

## SERVICE TIP #R1

### TROUBLESHOOTING DITTING COFFEE GRINDERS

#### DO NOT TAKE THE GRINDER APART BEFORE READING THE FOLLOWING:

1. **Grinder is Clogged** (The red light comes on and the motor hums. Then you hear a “click” and the red light goes off). Or **Grinder Cannot Be Turned On** (red lamp does not come on).
  - a. Check whether the power cable is properly connected.
  - b. Check the **circuit breaker** UNDER the base of the grinder in the right rear corner.  
Newer model 1403 3-phase grinders have a rocker breaker switch on the lower right side of the machine. Older model KFA1403 does not have a circuit breaker.
    - i. Follow these steps when attempting to reset the grinder:
      1. Turn the switch to the “Off” position.
      2. Check for coffee grounds clogged in the discharge tube. See Paragraph #2 for instructions.
      3. Place a bag under the discharge tube.
      4. Adjust the grind setting on the right side to #9 to allow more space between the discs.
      5. Carefully lean the grinder towards you to feel for the circuit breaker under the machine. You will have to press hard to engage the breaker. You will not necessarily feel the breaker moving when you press it, but you will hear a “click” when it has been engaged.
      6. Start the grinder and let it continue to run until everything in the grinding chamber is ground and discharged from the grinder.
      7. If the grinder starts but then the circuit breaker is tripped again after a moment, you may need to open the grinder and clean out the grinding chamber. See Paragraph #3 for instructions.
    - ii. Try another electrical appliance in the same outlet to make sure that there is power in the outlet. (110 volt grinders only).
    - iii. If another appliance plugged into the same outlet does not work, check the main circuit panel in the store.

2. **Clogged Discharge Tube:**  
**Switch the grinder OFF and unplug the power cable.**

#### **Four basic problems will cause clogging of the grinder:**

- a. **Full coffee bag** under the discharge tube, blocking the exit of ground coffee.
- b. **Worn grinding discs** which can no longer cut the beans.
- c. **Worn wings** on the lower rotating plate, unable to push out the ground coffee from the grinding chamber.
- d. **Dislodged transition tube** between the grinding chamber and the discharge tube, blocking the flow of coffee out of the grinding chamber. The transition tube should be perfectly round and free of crimps and tears.



**As you perform the following steps, watch for clues as to the cause of your problem.**

- a. Clear out all ground coffee packed in the discharge tube by inserting a wooden pencil in the opening and gently stirring it. If the discharge tube is full of coffee, you obstructed the flow of ground coffee by having a coffee bag smaller than the amount of coffee being ground. Use a larger bag and be sure the grounds are being packed to the bottom of the bag by tapping on the bag while grinding the last 3<sup>rd</sup> of the beans.
- b. **Do not lift the hopper (funnel) while it contains coffee beans.**
- c. Remove the coffee beans from the hopper, using a vacuum cleaner if necessary.
- d. Remove the 4 corner screws holding the lid/cover assembly and remove it with the hopper.
  - i. **On 804 model grinders**, loosen the right rear STOP lock.
  - ii. Hold the hopper assembly, twist it 30° counter-clockwise and lift.
- e. Dismantle the stationary disc flange by removing the 4 cheese head screws. Pull out the stationary disc and set it aside. If the stationary disc does not come out easily, tap the circumference where the bolts are located with the handle of your screwdriver. This should loosen any coffee grinds that may be wedged between the disc and the grinding housing.
- f. Check whether the lower grinding disc (on the rotating plate) is spinning freely. (Use a socket wrench on the center bolt of the rotating plate to turn it easier). If the rotating plate does not turn freely, your problem is a frozen bearing or a bad felt seal around the rotating plate that needs to be changed. This could be caused by extended use of flavored coffee.
- g. As you turn the rotating plate, see if the wings along its circumference are wiping all the coffee out of the exit hole. Is there a thick layer of coffee along the outer wall of the grinding area? An easy measurement of the rotating plate is to use 3 standard-size business cards:
  - i. Clean away the coffee between the end of each wing and the outer wall.
  - ii. Check if you can fit the 3 business cards between each wing and the wall. You should have to push the cards into place. If they slide in easily or if you can fit more than 3 cards in between any of the wings and the outer wall, the rotating plate is worn and should be changed to avoid further clogging.
- h. Clear the obstruction in the exit hole towards the discharge housing with a small screwdriver or pencil. Be careful not to dislodge the rubber transition tube. The transition tube between the grinding chamber and the discharge tube must be perfectly round. Any crimp or tear in the tube will result in clogging.
- i. If the discharge tube was not full, nor was the inside edge of the grinding chamber around the rotating plate's wings, then the clogging was due to a foreign particle in the grinding chamber or worn out grinding discs. If you cannot find foreign matter and everything else looks good, you need to change the grinding discs.

**To reassemble the grinder, see Paragraph 4 on the following page.**



### 3. Foreign Matter in the Grinding Chamber:

- a. Set the adjusting knob on the right side to #9 and start/stop the grinder a few times. 50% of the time, the problem might clear itself out. If the grinder still does not run, proceed as follows.
- b. **Switch the grinder off and unplug the power cable.**
- c. **Do not lift the hopper (funnel) while it contains coffee beans.**
- d. Remove the coffee beans from the hopper, using a vacuum cleaner if necessary.
- e. Remove the 4 corner screws holding the lid/cover assembly and remove it with the hopper.
  - i. **On 804 model grinders**, loosen the right rear STOP lock.
  - ii. Hold the hopper assembly, twist it 30° counter-clockwise and lift.
- f. Dismantle the stationary disc flange by removing the 4 cheese head screws. Pull out the stationary disc and set it aside. If the stationary disc does not come out easily, tap the circumference where the bolts are located with the handle of your screwdriver. This should loosen any coffee grinds that may be wedged between the disc and the grinding housing.
- g. Remove any foreign matter and vacuum the grinding chamber. Inspect the grinding discs and rotating plate for possible damage or wear.

### 4. Reassembling the Coffee Grinder:

- a. Cleanliness is a must to get a good, uniform grind. All mating parts have to be very clean to get Turkish fine grind with your grinder. Your grinder parts are precision machined. Even the smallest amount of coffee particles between parts would nullify the precision quality work.
- b. The circumference of the grinding chamber where the 4 cheese head screws attach, as well as the mating surface on the stationary disc flange (top plate) must be perfectly clean.
- c. Replace the stationary disc flange and the 4 cheese head screws, and tighten the screws.
- d. Replace the cover with the plastic funnel.
- e. Set the adjustment on #1 (Turkish) and grind 10-15 beans. The output should be a very fine powder. If the output is not satisfactory, adjust the grinder as in Paragraph #5 below.

### 5. Adjusting the Grinder for the Proper Grind

- a. Turn the grinder on with no coffee in it.
- b. Turn the adjustment setting on the side to #1.
- c. Loosen the center screw of the adjusting knob about 3/16<sup>th</sup> of an inch. You need to be able to pull the adjusting knob away from the machine to disengage the gear.
- d. Pull out the knob and, while still in the pulled position, turn it until the #5 is in front of the red arrow. Release the adjusting knob.
- e. Turn the adjusting knob **slowly** towards #1 until you hear metal scraping (the grinding discs touching). If they do not touch, repeat step #5 above.
- f. When you hear the metal, turn the adjusting knob back the distance on **one line**. (Counter clockwise).

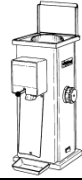

- g. Pull out the adjusting knob and, while in the pulled position, place the #1 against the red arrow and release the knob. The knob will engage the internal gear.
- h. Position the aluminum cover on the adjusting knob to fit in the groove, and tighten the center screw.
- i. Your grinder should now be adjusted properly, and all settings should match the proper grinds.

**Testing the grind:** Place 10-15 beans in the hopper and grind on the #1 setting. The output must be pulverized (powder).

**Notes:** If on the #1 setting the coffee comes out slowly or in small balls, the setting is too close. Repeat the above procedure. If the grinding is still too slow, replace the grinding discs.

6. **Uneven Grinding or Excessive Dust Particles:**
  - a. Indication of badly worn grinding discs. Replace the grinding discs as soon as possible.
7. **Coffee Grinds Very Slowly**, and the grinding housing heats up.
  - a. The grinding discs are worn out. Instead of grinding the coffee, they are chewing the beans. Replace the grinding to return the quality back into your grinder and prolong the life of the motor.
8. **Metal Noise After Stopping the Grinder** on #1 Turkish setting:
  - a. The discs are not adjusted properly and are too close. Follow the Adjusting instructions in Paragraph #5 above. If you continue to use your machine with the grinding discs adjusted too close together so that they are touching, you will wear your discs down very quickly, and they will not be resharpenable.

**CAUTION:** If coffee beans have fallen inside the grinder, you **MUST** clean out the base of the grinder to prevent future problems, including the possibility of fire. You need the airflow to keep the motor cool. Accumulation of beans at the base can restrict airflow and overheat the motor and/or cause a fire.

- a. **UNPLUG THE GRINDER.**
- b. Place the grinder on its back on the table. Make sure the grinder is forward enough so that the cable is not crimped and can hang freely.
- c. Remove the 4 corner screws holding the base onto the grinder. Be sure to have a firm hold on the base so that it does not fall away from the machine.
- d. Gently pull the base away from the housing, making sure not to pull out any of the wires from the base terminals.
- e. Vacuum the fallen beans at the base.
- f. Replace the screws to hold the base in place.
- g. Stand the grinder upright, plug in, and test.

Visit our website at [www.ditting.com](http://www.ditting.com) for this and other service tips.



U.S. Distribution Center  
8801-B Smiths Creek Rd, Wales, MI 48027  
Tel 810-367-7125 Toll-Free 800-835-5992  
Fax 810-367-7130

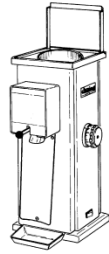

*Serving the Whole-Bean  
Coffee Market Since 1968*  
[www.ditting.com](http://www.ditting.com)

**Ref. Models:**

804 Series  
805 Series  
903 Series  
1203 Series  
1403 Series  
1800 Series

### SERVICE TIP #R3

## DIRECTION OF ROTATION

ditting grinders **MUST TURN COUNTER-CLOCKWISE**. If the grinder turns clockwise, the ground coffee will not come out and **WILL CLOG** the grinder.

To check for direction, turn the machine on for a moment and then turn it off. As the motor is slowing down, look down through the hopper base opening at the turning nut, and make sure that it is turning counter-clockwise. If it is not, do the following **BEFORE GRINDING ANY COFFEE**.

**MODELS 804 / 805 / 903 / 1203 – 120 volt grinders:** This is needed **ONLY** if a service person worked on the base wiring and did not wire the motor properly.

1. You must have an Ohmmeter to check the resistance of the pairs of wires.
2. From the motor, there are two sets of wires going to the terminal block on the base.
  - a. One color with the lower resistance is the primary winding.
  - b. The other color wires with the higher resistance are the secondary motor winding.
3. Swap the two secondary wires, and your rotation will be reversed.

This needs to be done only once for proper wiring of the grinder.

**MODEL 1403 – 220 volt, 3 Phase grinders:** This is needed **ANYTIME** you plug the grinder into a new outlet.

**The electrical configuration of the outlet depends on the wires coming from the power company transformer, and you must check and correct for rotation every time you move the grinder into a new 3 phase outlet.**

1. Unplug the grinder.
2. Open the electric plug of the grinder. You will have 4 wires: a green (ground), and 3 other wires, normally 1 black, 1 red, and 1 white. (The factory may change the color of the wires without notice)
3. You can take any two of the wires **EXCEPT THE GROUND WIRE** and swap them.
4. Make sure the screws are tight over the changed wires.
5. Close the plug and install the screws.
6. Check the grinder for rotation.

**If you have any problems or questions, consult Ditting USA at 810-367-7125.**

Visit our website at [www.ditting.com](http://www.ditting.com) for this and other service tips.



U.S. Distribution Center  
8801-B Smiths Creek Rd, Wales, MI 48027  
Tel 810-367-7125 Toll-Free 800-835-5992  
Fax 810-367-7130

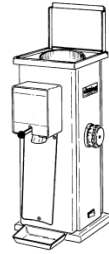

*Serving the Whole-Bean  
Coffee Market Since 1968*  
[www.ditting.com](http://www.ditting.com)

**Ref. Models:**

804 Series  
805 Series  
903 Series  
1203 Series  
1403 Series  
1800 Series

## SERVICE TIP #R4

### CLEANING THE GRINDER

The grinding discs and grinding chamber should be cleaned at least once a week, or every day for stores grinding extremely oily coffee. For a store using oily, dark roast coffee, without regular and frequent cleaning, the grinder may eventually jam until the grinding chamber has been cleaned.



The coffee grinder must only be cleaned with a dry cloth.  
Do not use an alkaline cleaning agent.  
Do not spray coffee grinder with water and/or steam.  
Using anything other than a dry cloth can result in a short-circuit and may damage the unit. The use of alkalis can affect the flavor of the coffee.

1. **Unplug the grinder.**
2. Clean the body of the grinder.
  - a. Use a paper towel and mild dishwasher detergent to clean the body shell, cover lid and the inside of the hopper.
3. Clean the discharge tube.
  - a. Use a brush and paper towel to clean in and around the discharge tube. Be gentle when inserting a brush into the discharge tube so as not to dislodge the rubber transition tube joining the grinding chamber to the discharge tube.
4. Loosen the screws holding the cover lid and hopper, and remove them.
  - a. Use a paper towel or towel to wipe down the hopper of any accumulated oils.
  - b. Use a brush to clear the built-in magnet on the underside of the hopper.
5. Remove the screws that hold the top stationary plate and pull the plate up. One of the grinding discs is installed on the bottom of this plate.
  - a. Use a vacuum with an extension hose to vacuum up any coffee particles that may be in the grinding chamber.
  - b. Use a paper towel and a brush to clean the grinding chamber and grinding discs of any leftover coffee particles. The teeth of both grinding discs and the “wings” of the rotating plate (to which the second grinding disc is installed) must be completely free of coffee and oils. **Do not remove the grinding discs from their positions.**
  - c. Once the grinding chamber has been thoroughly cleaned and there is no more coffee dust or oil visible, reassemble the grinder, making sure all screws are replaced and tightened.

Visit our website at [www.ditting.com](http://www.ditting.com) for this and other service tips.



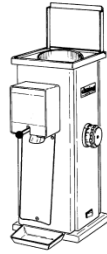

## **SERVICE TIP #R5**

### **Recommendations for Preventive Maintenance -- Ditting Retail Coffee Grinders --**

- Check switch for power.
- **UNPLUG GRINDER** prior to performing any further maintenance.
- Discharge tube:
  - a. Wipe down tube for any coffee dust.
  - b. Check for two rubber grommets on back of discharge tube and replace if missing or cracked/hardened.
  - c. Check the rubber transition tube (part 40197) between the grinding chamber and discharge tube to ensure both ends of the transition tube are perfectly round and not pinched or restricted.
- Hopper:
  - a. Wipe down hopper with lightly moist, lint-free towel to remove any oil build-up.
  - b. Remove hopper, turn upside down, and clean all debris from magnet.
- Grinding chamber:
  - a. Open grinding chamber and clean any coffee dust or oils by vacuuming up and wiping down with clean towel – do not use any cleansers in grinder.
  - b. Visually inspect chamber, making sure there are no dents or nicks in grinding discs, rotating or stationary plates caused by foreign objects.
  - c. Manually spin the rotating plate (counter-clockwise) to make sure it spins complete revolutions without any binding or noticeable resistance. If it does, there may be an issue with the felt ring -- the felt ring can be visibly inspected by removing the rotating plate. (See Ditting's Service Tip for Removing the Rotating Plate)
  - d. Keep in mind that the mating surfaces of the stationary plate and housing **MUST** be free of ALL coffee dust before reassembling. Reassemble grinding chamber and replace hopper.

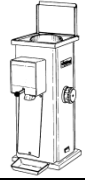

- Calibrate the grinding discs and ensure you can obtain a very fine grind by grinding a test sample on the #1 setting.
  - a. Symptoms of wear:
    1. No longer can get Turkish grind after properly calibrating the grinder;
    2. Coffee will come out slower and hotter;
    3. Circuit breaker will start to trip on a fairly regular basis.
  - b. The average retail store changes their discs every 12-18 months
- Base area:
  - a. CAREFULLY open base and clean any loose coffee beans or grounds. If there is a heavy build up of coffee grounds in the base, recheck the rubber transition tube between the discharge tube and grinding chamber to ensure it is perfectly round at both ends with no pinches, tears or cracks.
  - b. Make sure no wires are exposed or starting to wear.
  - c. If the grinder is equipped with a vibrator plate, make sure bag shaking bearing is parallel to the fan shroud and base. If it is not, loosen the bottom screw on the vibrator plate, turn the bearing into position, hold in position with pliers, and tighten screw.

NOTE: If the grinder is equipped with a vibrator plate, do not overturn the three screws (one in each upper corner, and one in the bottom center position on the vibrator plate). Overturning may result in the breaking of the rubber head from the stud (part 55707), or it may turn the bearing (part 54902) out of alignment in the vibrator assembly.



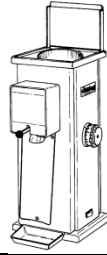

## SERVICE TIP #R6

### FREQUENT CLOGGING

#### FOR A GRINDER THAT KEEPS CLOGGING UP:

**When the grinder clogs up, stop the grinder and unplug it. DO NOT CLEAN ANYTHING.**

Inspect the inside of the discharge tube (spout).

- If the spout is full of coffee, you were grinding more coffee than the bag or filter could hold or the coffee was not packing to the bottom of your bag, and the ground coffee backed up into the spout and caused the grinder to choke and clog up.
- If the spout is clean (some loose coffee particles are okay):
  - Remove the hopper and place aside.
  - With a large screwdriver, remove the screws holding the stationary disc. Remove the plate and place aside.
- 1. Visually inspect the grinds in the grinding chamber and note where the coffee is accumulated. If the coffee grounds are stuck against the wall of the grinding chamber, one of two things is happening - the rubber transition tube between the grinding chamber and the metal discharge tube is:
  - a) deformed and/or has become smaller due to heat and time and is now restricting the flow of coffee particles out of the grinder; or
  - b) out of alignment with the opening on the back side of the spout, and the coffee is restricted and backing up

This rubber tube must be perfectly round at both ends without pinches, cracks or tears. REPLACE THE RUBBER TRANSITION TUBE (part 40197), and MAKE SURE IT LINES UP WITH BOTH THE HOLE ON THE BACKSIDE OF THE DISCHARGE TUBE AND THE EXIT HOLE FROM THE GRINDING CHAMBER.

- 2. Inspect the wings along the outer edge of the rotating disc to check for any wear or broken/damaged areas.
    - These wings help push the ground coffee out of the grinding chamber through the hole in the transition tube. If they are broken or worn down, the ground coffee will not be able to exit the chamber fast enough, and the grinder will back up.
    - If you can place three standard size business cards between the tip of any of the wings and the outer wall of the grinding chamber (measure each in case of damage), and if they are not snug, the rotating plate is worn.
- REPLACE THE ROTATING PLATE

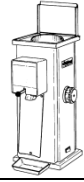

3. If the ground coffee particles are accumulated between the center of the grinding chamber and the inner edge of the grinding disc but not outside the grinding disc, then your grinding discs are too dull and are not able to grind the coffee, causing the grinder to back up and jam.

REPLACE THE GRINDING DISCS

**PLEASE NOTE:** If the wings on the rotating plate are worn and you change the grinding discs, the jamming problem will likely worsen. The sharp grinding discs will cut the beans faster, but the grounds will not be able to get out of the grinding chamber fast enough.

If your discs are not worn beyond repair, they may be able to be resharpened. Buy a new set, then send your old set to our office for evaluation and/or exchange for a resharpened set. (Prices vary by model)

If in doubt, always feel free to call our technical support team for free assistance.

Visit [www.ditting.com](http://www.ditting.com) for this and other service tips.

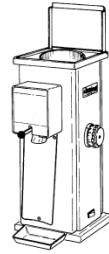

## SERVICE TIP #R9 GRINDING DISC REPLACEMENT

Be sure to use a large, industrial flat blade screwdriver to avoid stripping the screws.

### Removing the Old Discs:

6. **Unplug the grinder.**
7. Remove the plastic hopper and stationary plate.
  - a. 804 model grinders – loosen the rear left hopper lock screw. Hold the plastic hopper and twist it counter-clockwise 30°, and lift. Remove the screw holding the stationary plate down, and remove the plate.
  - b. 805 model grinders – unlock the hopper safety lock before twisting it up and off. Remove the top cover. Remove the discharge tube and stationary plate to reveal the lower grinding disc.
  - c. All other models – remove the screws holding the top plate on the housing, and lift the cover/hopper assembly. Remove the screws holding down the stationary plate, and remove the plate by placing your thumb in the center hold and pulling it up. If the disc does not move as you are pulling up with your thumb, tap the edge of the disc with the plastic handle of the screwdriver.
8. Remove all the screws holding on the discs. To keep the rotating disc from turning, insert the plastic handle of a tool inside the exit hole in the grinding chamber. Be careful not to damage the heads of the screws, as it would make it difficult to remove them. (**Note:** The 805 uses magnets in place of screws to hold the grinding disc in place. Place the tip of your screwdriver in the groove on the inner edge of the discs to “pop” off).
9. **Clean the areas marked “X”** with steel wool or a single edge razor blade, and make them perfectly clean. If the mating surfaces are not clean, you cannot get a fine grind.

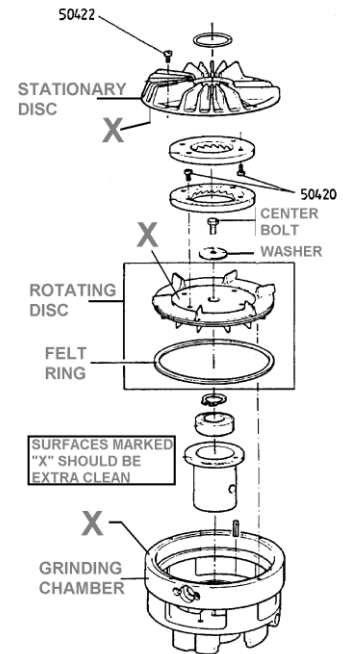

### Installing the New Discs:

1. Make sure that the discs are clean with no coffee or dirt particles on the underside.
2. Check the back of the discs – newer-style machined discs are marked “top” and “bottom” for positioning.
3. If you are installing resharpened discs and you were provided spacers, use them. If you have 1 spacer, install it under the top disc. If you have 2 washers, install a spacer under each disc.
4. Install the discs, making sure the screws are tight.
5. Make sure the top edge of the grinding chamber and the underside of the stationary disc are perfectly clean.
6. Adjust the grind setting to #9.
7. Align the screw holes of the stationary disc with the grinding chamber, and insert the screws tightly.
8. Replace the cover with the plastic hopper. Now you can plug in the grinder.
9. With the adjustment knob on #9, turn the grinder on.
10. Loosen the center screw of the adjusting knob about 3/16<sup>th</sup> of an inch. You need to be able to pull the adjusting knob away from the machine to disengage the gear.
11. Turn the adjusting knob **slowly** towards #1 until you hear metal scraping (the grinding discs touching). If they do not touch, pull the knob away from the grinder and, while pulled, set the 9 in front of the red arrow and adjust towards #1 as above.
12. When you hear the metal, turn the adjusting knob back the distance of **one line**. (Counter clockwise).
13. Pull out the adjusting knob and, while in the pulled position, place the #1 against the red arrow and release the knob. The knob will engage the internal gear.
14. Position the aluminum cover on the adjusting knob to fit in the groove, and tighten the center screw.
15. **If your grind is not powder, repeat the installation section.**



U.S. Distribution Center  
8801-B Smiths Creek Rd, Wales, MI 48027  
Tel 810-367-7125 Toll-Free 800-835-5992  
Fax 810-367-7130

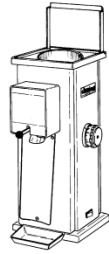

*Serving the Whole-Bean  
Coffee Market Since 1968*  
[www.ditting.com](http://www.ditting.com)

**Ref. Models:**

804 Series  
805 Series  
903 Series  
1203 Series  
1403 Series

## SERVICE TIP #R10

### GRINDER ADJUSTMENT / CALIBRATION

This simple procedure is for adjusting the grinding discs. If you remove or change the grinding discs, you will need to calibrate the grinder.

10. Turn the grinder on with no coffee in it.
11. Turn the adjustment setting on the side to #1.
12. Loosen the center screw of the adjusting knob about  $\frac{3}{16}$ <sup>th</sup> of an inch. You need to be able to pull the adjusting knob away from the machine to disengage the gear.
13. Pull out the knob and, while still in the pulled position, turn it until the #5 is in front of the red arrow. Release the adjusting knob.
14. Turn the adjusting knob **slowly** towards #1 until you hear metal scraping (the grinding discs touching). If they do not touch, repeat step #5 above.
15. When you hear the metal, turn the adjusting knob back the distance of **one line**. (Counter clockwise).
16. Pull out the adjusting knob and, while in the pulled position, place the #1 against the red arrow and release the knob. The knob will engage the internal gear.
17. Position the aluminum cover on the adjusting knob to fit in the groove, and tighten the center screw.
18. Your grinder should now be adjusted properly, and all settings should match the proper grinds.

**Testing the grind:** Place 10-15 beans in the hopper and grind on the #1 setting. The output must be pulverized (powder).

**Notes:** If on the #1 setting the coffee comes out slowly or in small balls, the setting is too close. Repeat the above procedure. If the grinding is still too slow, replace the grinding discs.

**Special:** If you want to calibrate the grinder to grind coarser coffee than Ditting's French Press setting AND you will not need to grind Turkish, turn the adjusting knob back TWO lines in step #7. If you need even coarser coffee after you have tested it, repeat the process and turn back  $2\frac{1}{2}$  - 3 lines in step #7.

Visit our website at [www.ditting.com](http://www.ditting.com) for this and other service tips.



U.S. Distribution Center  
8801-B Smiths Creek Rd, Wales, MI 48027  
Tel 810-367-7125 Toll-Free 800-835-5992  
Fax 810-367-7130

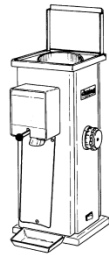

*Serving the Whole-Bean  
Coffee Market Since 1968*  
[www.ditting.com](http://www.ditting.com)

**Ref. Models:**

804 Series  
805 Series  
903 Series  
1203 Series  
1403 Series

## SERVICE TIP #R18

### ROTATING DISC REMOVAL / REPLACEMENT

1. **UNPLUG THE COFFEE GRINDER.**
2. Remove the four screws holding the lid/cover assembly and remove it with the hopper.
3. Remove the screws that hold the top stationary disc flange.
  - a. Pull out the stationary disc and set it aside. If the stationary disc does not come out easily, tap the circumference where the bolts are located with the handle of your screwdriver. This should loosen any coffee grinds that may be wedged between the disc and the grinding housing.
4. Loosen the screw in the center of the adjusting knob (on the right side of the machine) and slowly remove the screw, the aluminum backing plate, and the spring behind it.
  - a. Unscrew (counter-clockwise) the adjusting gear/cone and set aside.
5. Remove the center bolt holding the lower rotating disc. You need to place the soft handle of a pair of pliers in the opening of the grinding chamber where the coffee goes out to the discharge tube to prevent the rotating disc from moving.
  - a. Take out the washer behind the bolt and replace the bolt in the hole (finger tight).
6. Take a large wood dowel (or a piece of hard wood), place it on the head of the center bolt and hit it with a hammer (hard, if need be) to push away the cone tipped shaft from the lower rotating plate. The rotating disc is press-fit on the motor shaft.
7. Remove the rotating plate and replace it with the new one.
  - a. **Put some mineral oil on the new felt gasket to lubricate it and to make the installation easier. DO NOT USE OTHER OILS OR GREASES. Guide the disc into the housing. Do not force it, or you could damage the felt seal.**
8. Remove the center bolt, replace the washer that you had taken out, and tighten the bolt back in place. Place the handle of the pliers back into the outlet hole and tighten the center bolt.
9. Reinstall the adjusting gear/cone in the grinder and turn it clockwise until the rotating plate's wings clear the grinding housing and the lower plate spins freely.
10. Clean the mating surfaces free from dirt and coffee, replace the top stationary disc and install and tighten the screws.
11. Replace the cover assembly with the hopper.
12. Plug the grinder into the outlet.
13. **CALIBRATE AND ADJUST THE GRINDER FOR PROPER GRIND.**

Ask for the GRINDER ADJUSTMENT/CALIBRATION service tip or see our website at [www.ditting.com](http://www.ditting.com) for this and other service tips.



U.S. Distribution Center  
8801-B Smiths Creek Rd, Wales, MI 48027  
Tel 810-367-7125 Toll-Free 800-835-5992  
Fax 810-367-7130

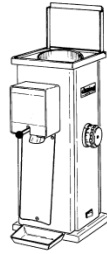

**ditting**<sup>®</sup>  
— SWISS —  
*Serving the Whole-Bean  
Coffee Market Since 1968*  
[www.ditting.com](http://www.ditting.com)

**Ref. Models:**  
804 Series  
805 Series  
903 Series  
1203 Series

## SERVICE TIP #R22

### CORD REPLACEMENT PROCEDURE

1. **UNPLUG THE GRINDER.**
2. **Place the grinder on its back on the table.** Make sure the grinder is forward enough so that the cable is not crimped and can hang freely.
3. **Remove the 4 corner screws holding the base onto the grinder. Be sure to have a firm hold on the base so that it does not fall away from the machine.**
4. Gently pull the base away from the housing, making sure not to pull out any of the wires from the base terminals. You may let it hang gently in front of the grinder. Place a stool, boxes, or another form of support under it.
5. Remove the nut holding the green (ground) wire and set it aside.
6. On the base, mark the position of the black and white wires of the power cord.
7. Gently pull the white and black wires of the power cord from the terminal block. Be careful not to pull other wires with it.
8. Loosen the black cable camp nut and pull the cable away from the grinder and remove it.
9. Install the new cable into the base of the grinder and install and tighten the black nut.
10. Attach the green wire on the base stud and replace the lock washer and nut. Tighten.
11. Press the black wire where you marked the original position, and press the white wire on its original position. Press them on the flat silver terminals as far as they will go.
12. Check for any loose wires that might have pulled off.
13. Gently position the base back onto the grinder housing, making sure that no wires are pinched between the base and the walls of the grinder.
14. Install and tighten all 4 screws to hold the base in place.
15. Set the grinder upright. Plug it into the outlet and test it.

Visit our website at [www.ditting.com](http://www.ditting.com) for this and other service tips.